



IST-5750.AN01.03

File: IST-AN750_5750.AN01.03_EN_Installation.docx

FIXED GAS ANALYZER UNIT

AN750 Central Unit

INSTALLATION INSTRUCTIONS

TECNOCONTROL S.r.l.

Via Miglioli 47, 20090 SEGRATE (MI), ITALY - Tel. (+39) 02 26922890 - Fax (+39) 02 2133734

http: www.tecnocontrol.it

e-mail: info@tecnocontrol.it

INDEX

GENERAL DESCRIPTION	3
DESCRIPTION OF THE SYSTEM	4
MEASURED AND CALCULATED PARAMETERS	5
INSTALLATION OF THE AN750 UNIT	6
INSTALLATION OF THE PROBES CONNECTED TO THE AN750 UNIT	6
<i>TS345 - (Tf) Temperature probe of the fumes and oxidizing air (PT100)</i>	6
<i>TS346 - (Ta) Ambient temperature probe (PT100)</i>	6
<i>TS236 - Zirconium oxide oxygen probe</i>	7
<i>AN510 – Extracted fumes analyzer unit (CO)</i>	8
<i>TS352 – Vacuum pressure probe</i>	9
<i>AN400/I – Combustion chamber gas analyzer unit</i>	10
POSITIONING OF THE MAIN FUMES' ANALYSIS PROBES	11
ELECTRICAL CONNECTIONS	12
<u>Feed</u> (refer to diagram 1)	12
<u>Consensuses</u> (refer to diagram 5)	12
<u>Probe signals (4-20mA)</u> (refer to diagrams 2, 3, 4 and 5)	12
<u>Alarm relay outputs</u> (refer to diagram 1)	13
DIAGRAM 1 Feed and relay outputs	14
DIAGRAM 2 Only the TS345 Tf probe.	15
DIAGRAM 3 TS345 Tf and TS346 Ta common probes.	16
DIAGRAM 4 TS345 probes for Ta and Tf.	17
DIAGRAM 5 TS236 and AN510 probes and consensuses.	18
DIAGRAM 6 AN510/CO unit and consensuses	19
DIAGRAM 7 TS352 Dpr and Pr probes	20
DIAGRAM 8 AN400/I	21
OPERATING THE UNIT	22
ORDINARY MAINTENANCE	22
Substitution of the thermal paper	22
Assistance	22
TECHNICAL CHARACTERISTICS	23
AN750 central unit	23
TS345 temperature probe (Pt100 thermoresistance)	23
TS346 ambient temperature probe (Pt100 thermoresistance)	23
TS352 vacuum/pressure probe	23

Document name: IST-AN750_5750.AN01.03_EN_Installation.docx			
Subject : AN750 Fixed Combustion Analyzer Central Unit			
Rev.	Date	By	Notes
0	03/02/2009	UT/	Emesso Documento

GENERAL DESCRIPTION

As required by the standards in force of the Italian Republic, the adaptation of district heating systems that has as its objective the optimization of combustion efficiency must be equipped with instruments for continuous measuring and recording of certain parameters of the gas fumes exiting from the combustion chamber of the boiler, on the basis of the typology and capacity of the district heating system (e.g., in its minimum parameter configuration; temperature, free oxygen and carbon monoxide).

The system that fully satisfies the requirements in a reliable way with simple maintenance is composed of the following parts:

- A central unit coded on the basis of the number of the main printed circuit boards of the boilers installed:

– To manage one boiler	AN750/C1
– To manage one or two boilers	AN750/C2
– To manage up to three boilers	AN750/C3
– To manage up to four boilers	AN750/C4
- Boiler input expansion printed circuit board ES750

In all cases, ES750 main printed circuit boards of the boilers can be added to obtain the maximum configuration of four boilers, even after the installation.

Connectable probes (*maximum of eight for each main printed circuit board of the boiler*):

- Probe for measuring the oxidizing air temperature TS345
- Probe for measuring the ambient air temperature..... TS346
- Probe for measuring the fumes' temperature..... TS345
- Probe for measuring the free oxygen in zirconium oxide fumes TS236
- Extracted fumes' analysis unit (sensors (max 3): CO, O₂, NO, SO₂)..... AN510
 Complete with fumes' extraction probe with filter for the AN510.... SO105
- Two-sensor probe for measuring the vacuum at the base of the flue and the pressure in the combustion chamber TS352
- Gas leak analysis unit for leaks in the combustion chamber AN400/I

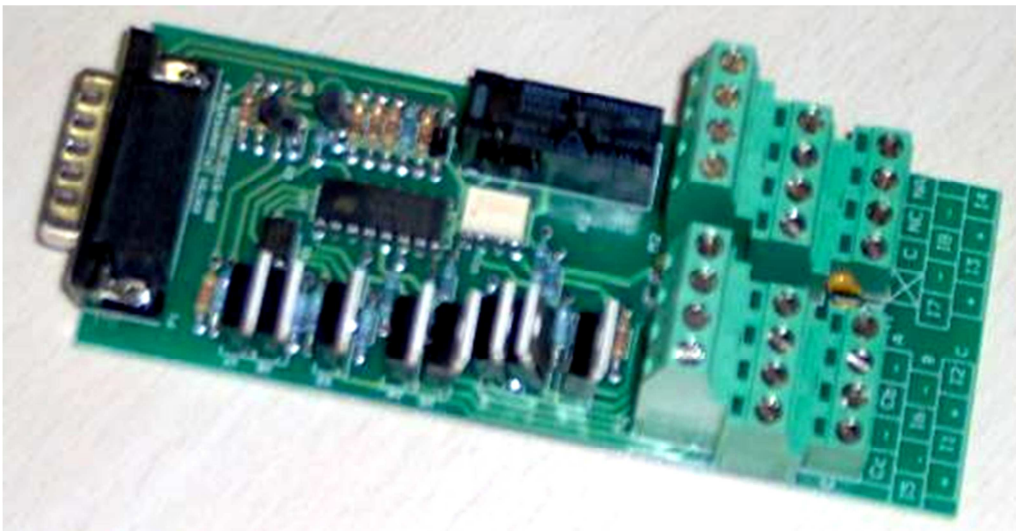

ES750 main printed circuit board of the boiler

DESCRIPTION OF THE SYSTEM

The AN750 is the central unit of the fixed fumes' analysis system which manages the signals coming from the probes installed in the boiler.

The enclosure of the central unit is in polypropylene and fitted with a transparent polycarbonate door; it has class IP65 protection.

On the front panel is a ¼" VGA STN (320 x 240 pixel) monochromatic graphic display with a blue background, 203 dpi thermal graphic printer with easy loading of the thermal paper roll (width 57.5mm with a reading durability of 5 years), roller for the printed paper, keypad, LED warning lights and an RS232 serial port.

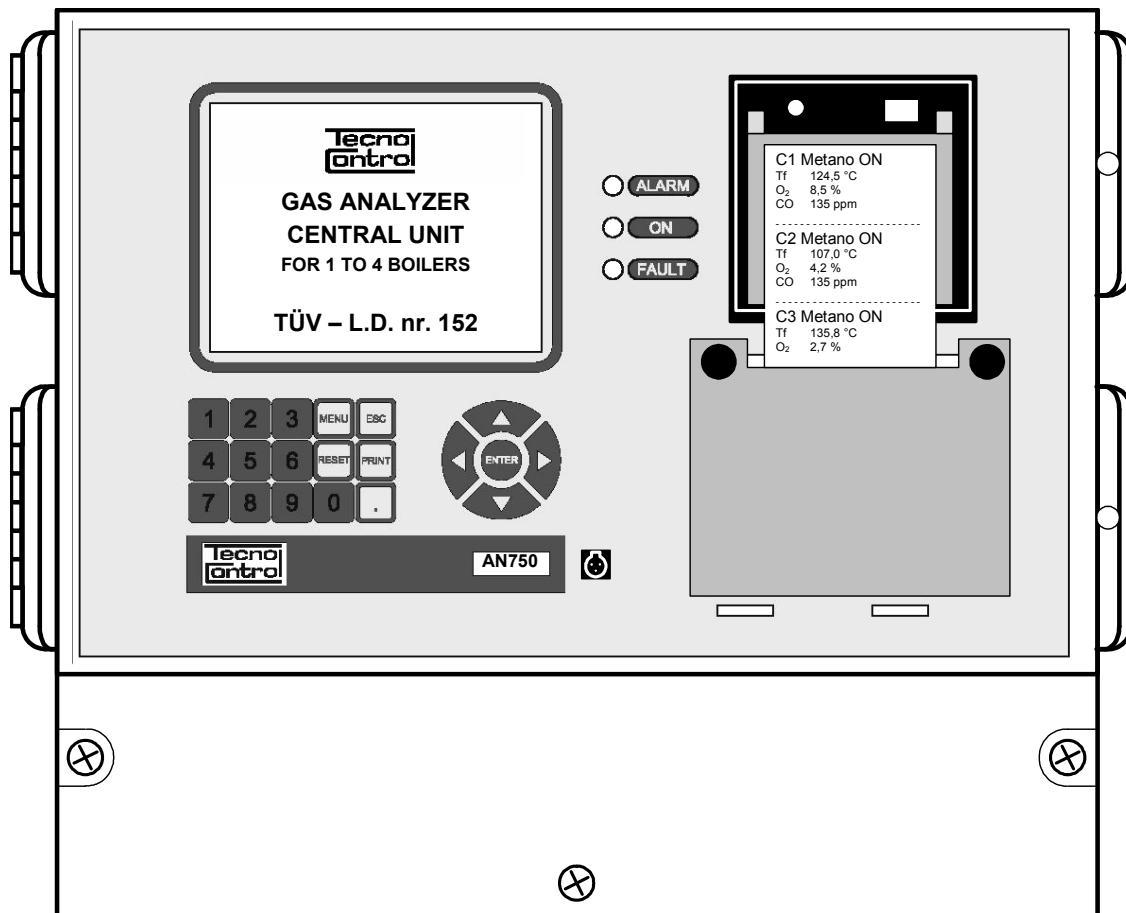

The following printed circuit boards are mounted inside the enclosure:

- The **main printed circuit board** includes a 16 bit micro-controller that processes all input data, visualizes it on the display and memorizes it in a memory. Furthermore, it manages the alarm relays and the printer. The unit can be connected to a PC to download the memorized data locally via the **SW750RC management software** using the RS232 serial port or remotely using the RS485 isolated serial port. *The SW750RC option includes the management software, RS232 serial cable and the RS485 serial port.*

On the basis of the type of enclosure, the following are mounted via an interconnecting circuit:

- The **Feed Module** with terminals to connect the electrical mains circuit and 3 output relays.
- The **ES750 boiler input expansion printed circuit board** (up to a maximum of 4) connect the probe signals of each boiler (8 x 4-20mA protected linear inputs, 2 consensus and 1 output relay).

It must be remembered that the instrument has not been designed as a safety control system. Therefore, if oxidizing air is used for the control, adequate measures must be taken to ensure that dangerous situations or malfunctioning of the entire boiler installation do not occur if there is a fault with the instrument.

MEASURED AND CALCULATED PARAMETERS

The AN750 unit processes the following measurable parameters (on the basis of the sensors installed):

Ta	Temperature of the oxidizing air (TS345) or the ambient temperature (TS346)
Tf	Temperature of the fumes (TS345)
O₂	Concentration of oxygen in the fumes (TS236 or AN510../O)
CO	Concentration of carbon monoxide in the fumes (AN510../C)
NO	Concentration of nitrogen oxide in the fumes (if installed in the AN510../N)
SO₂	Concentration of sulphur dioxide in the fumes (if installed in the AN510../S)
Dpr	Vacuum at the base of the flue (left sensor of the TS352)
Pr	Pressure in the combustion chamber (right sensor of the TS352)
CHc	Gas leaks from the combustion chamber (AN400/I)

The parameters calculated on the basis of the preceding parameters (on the basis of the probes connected):

CO₂	Calculation of the concentration of carbon dioxide on the basis of the type of combustible fuel set (only if the TS236 oxygen probe is installed)
NOx	Calculation of the total of nitrogen oxides (only if the AN510 is installed with the NO sensor)
CO*	Calculation of the undiluted CO referring to the content of oxygen set (only if the AN510 is installed with the CO sensor)
NO*	Calculation of the undiluted NO referring to the content oxygen set (only if the AN510 is installed with the NO sensor)
NOx*	Calculation of the undiluted NOx (only if the AN510 is installed with the NO sensor)
Eta	Calculation of the combustion efficiency (only if the TS345 fumes' temperature probe and the TS346 ambient air temperature probe are installed or the TS345 oxidizing air probe)
Cond	Calculation of the combustion efficiency for condensing boilers (only if the "Eta" efficiency calculation is configured and set)
Lamb	Calculation of the excess air (only if the TS236 oxygen probe is installed)
T on	Total functioning hours of the burner (the calculation is effectuated only when the burner flame is lit)
Mem	Percentage of the internal memory occupied by recorded data (only if the recording of the gas samples is configured)

The parameters calculated are not visualized and printed:

When the concentration of oxygen in the fumes exceeds 20.5%, or if the temperature of the fumes is less than the ambient air temperature.

When the burner is off.

As well as the visualization of the mentioned parameters, the system memorizes events and samples. Memorized events and gas samples can be printed or transferred to a PC using the SW750RC management software (optional).

Events represent anomalous situations (alarms, faults, switching on of the system, etc.).

Gas samples represent combustion data that the customer can choose the interval of sampling.

Depending on the inputs configured and how many of these inputs the customer needs to memorize, the system also calculates the quantity of gas samples that can be memorized and the estimated autonomy of the internal memory (depending on the time the burner is on).

N.B. Gas samples are memorized only with the burner on.

INSTALLATION OF THE AN750 UNIT

The AN750 is the control unit and normally is installed in the control zone or technical room of the district heating, or at least in an environment that normally does not exceed 30-40°C. The AN750 unit is connected to the relative probes (*in order of the type of installation and the parameters to measure*).

The connections to carry out using normal cable are relative to the electrical mains circuit (230V-50Hz), the consensus and the alarm contacts if required.

The connections to carry out using screened cable are for the probes (signals 4-20mA on two cores). The screened poles of the cables normally used are of 2 x 0.75mm² section or 0.5mm² for cables with more than two screened poles. The maximum distance between the probes and the AN750 unit with cables of 0.5mm² section is approximately 500 metres.

INSTALLATION OF THE PROBES CONNECTED TO THE AN750 UNIT

N.B. The same probes can be supplied with two types of different terminals.

As an alternative to the TS345, the TS347 probe can be supplied with the same connections (Type-K thermocouple) with 4-20mA output corresponding to the 0-600°C scale with \varnothing 8mm and a 500mm length.

TS345 - (Tf) Temperature probe of the fumes and oxidizing air (PT100)

A probe in a DIN enclosure with 4-20mA output corresponding to the 0-400°C scale. This model can be used to measure the temperature of the fumes (T_{fumes} Max. 500°C) and the pre-heated oxidizing air for the burner (in this case, install a probe for each boiler).

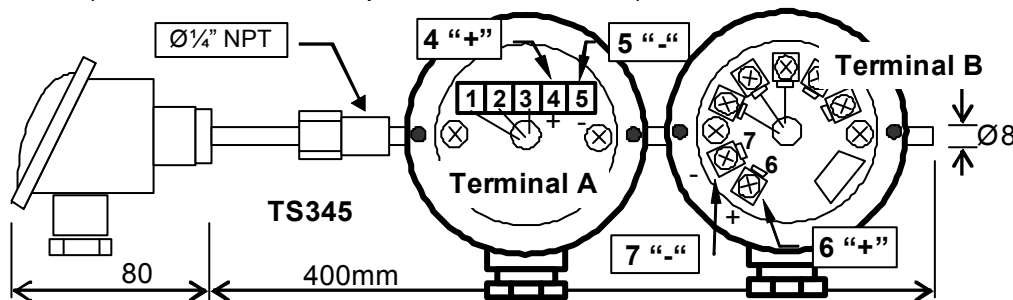

To measure the temperature of the fumes (Tf), the probe is installed on the flue expansion joint using a 1/4" NPT female duct section.

The supplied joint permits the regulation of the probe's position.

If the probe is utilized to measure the temperature of the oxidizing air (Ta) it must be installed on the pre-heated oxidizing air duct of the burner using a 1/4" NPT female duct section. The supplied joint permits the regulation of the probe's position.

TS346 - (Ta) Ambient temperature probe (PT100)

A probe with a 4-20mA linear output corresponding to the 0-100°C scale for measuring the ambient temperature; it includes a wall-fixing enclosure and 2 wall plugs. This probe is utilized as a common probe for more than one boiler that extracts oxidizing air directly from the ambience.

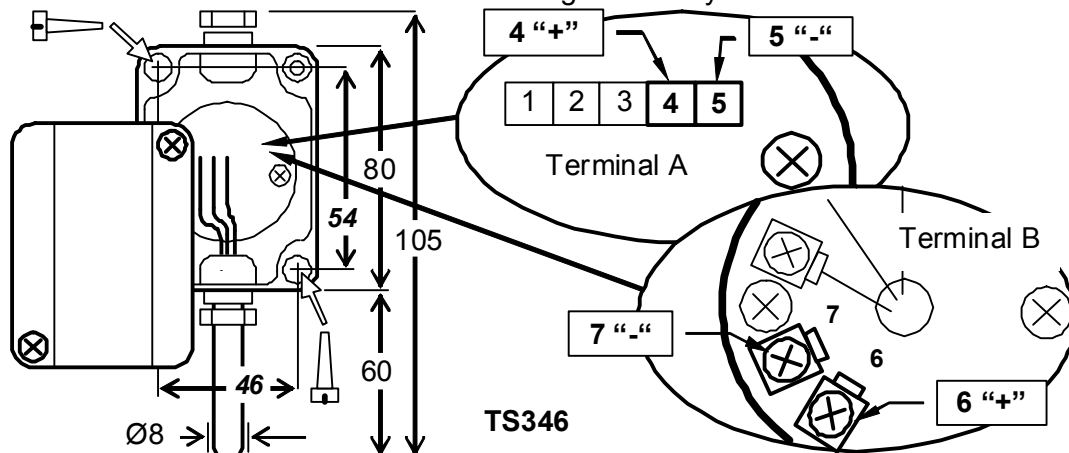

TS236 - Zirconium oxide oxygen probe

A probe with a 4-20mA linear output and a 0-21% O₂ scale for detecting oxygen (O₂) directly in the combustion fumes.

The probe is composed of a 210mm x 110mm x 120 mm aluminium enclosure with class IP55 protection. Inside the enclosure are the electrical mains feed circuit, the electrical circuit for measuring the concentration of oxygen and the terminals for the external connections.

The enclosure can be fixed to the wall by 2 wall plugs using the predisposed holes, or fixed to electrical conduits utilizing the supplied conduit brackets.

The probe body with the sensor is connected to the enclosure using a 1 metre length of cable. The probe body is orientated and completely inserted into the joint as illustrated in the design.

CAUTION: The probe cable, which is 1 meter long, it can not be extended or modified, this would cause a serious malfunction of the probe and the loss of warranty.

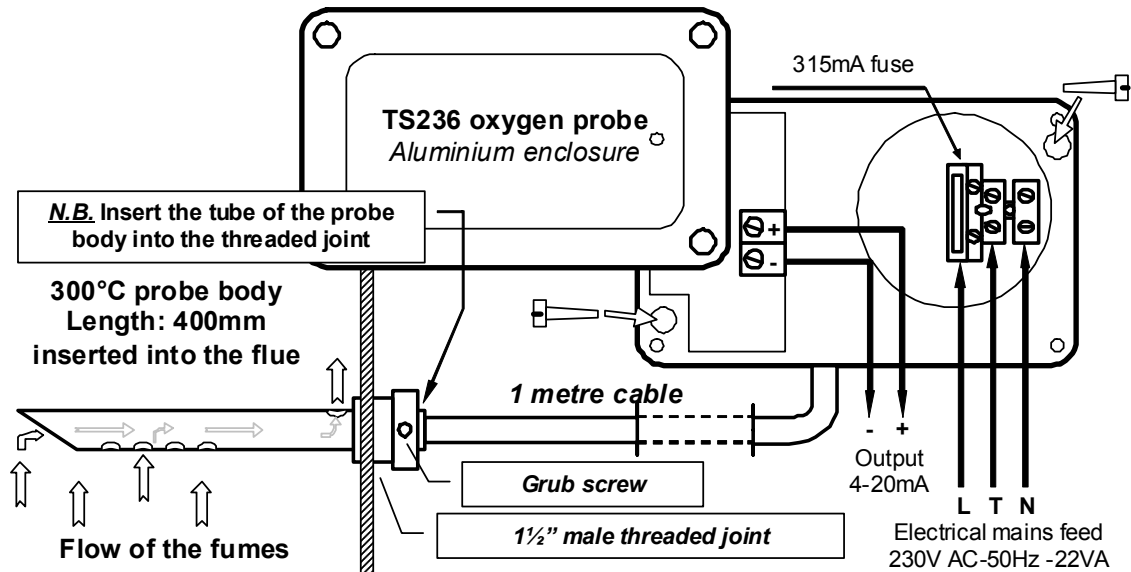

A request is available a probe body with a length less for ducts with small diameter.

The same probe is available on request (TS237) with the probe body made for fume temperatures up to 600°C (refer to design below) and utilizable on turbines for example.

Please note, that this type of probe body, for to measure correctly the residual oxygen, must be inserted into a duct with a discrete flow such as gas turbines.

This probe body is installed by mounting a counter-flange on the fumes' duct and is orientated as illustrated in the design.

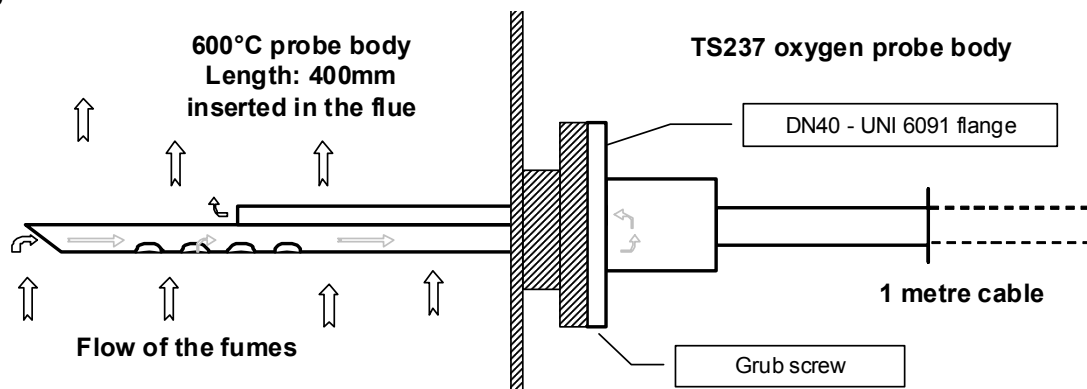

Consult the instruction specifications attached to the TS236 or TS237 for further information.

AN510 – Extracted fumes analyzer unit (CO)

A unit with a maximum of three sensors and relative 4-20mA outputs utilized to extract and analyze combustion fumes.

The unit can be supplied in various configurations. The carbon monoxide (CO) sensor is normally installed with a standard scale of 0-1,000 ppm (AN510../C.).

Before placing the order, other scales are available on request for the CO at 0-4,000 ppm (AN510../C2) and 0-10,000 ppm (AN510../C1) or up to 40,000 ppm. Furthermore, a second and third sensor can be installed to measure the NO and SO₂ (AN510/CNS) and/or O₂ (AN510/CO), etc., for example. The AN510 unit is composed of a 380 x 350 x 80 mm wall-mounted metal enclosure with IP54 class protection, equipped with 5 LEDs on the front panel.

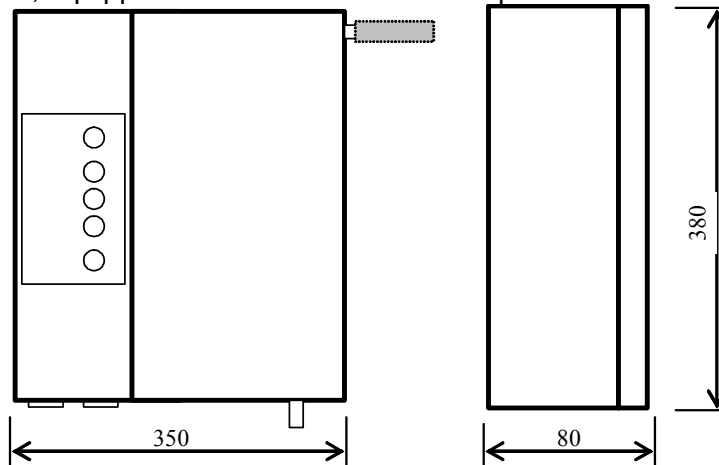

Inside the enclosure is the electrical mains feed circuit, the 4-20mA transmitters, the fumes' extraction circuit for measuring the concentration of CO and the connection terminal.

The AN510 unit is supplied complete with an SO105 – fumes' extraction filter probe to be installed using a 1½" female duct section welded directly onto the flue.

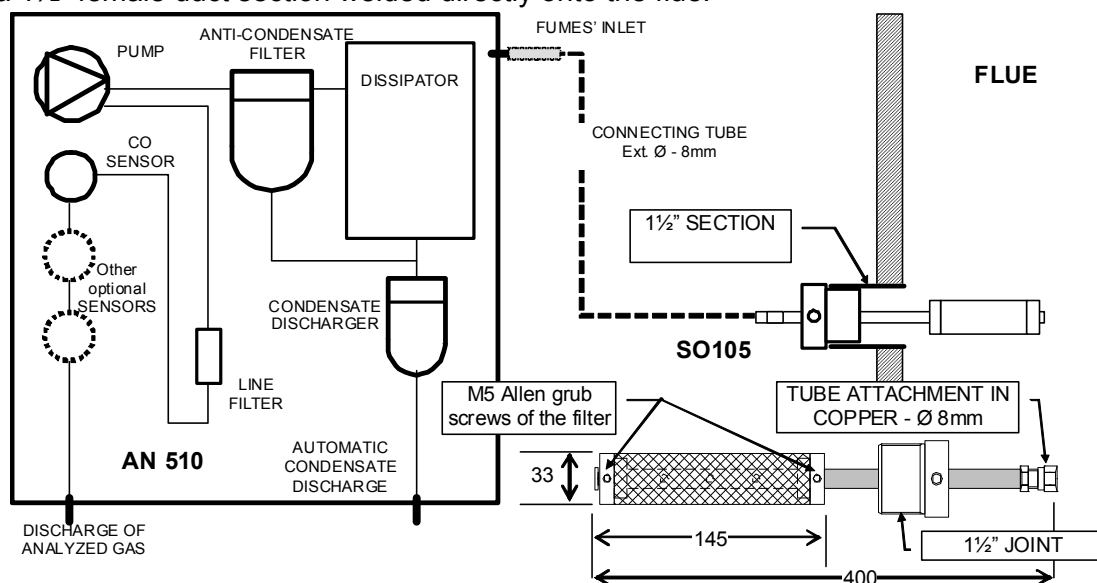

The AN510 analysis unit is installed near to the boiler to be analyzed and bearing in mind the environmental operating characteristics, it must be installed in a zone that does not exceed 45°C regardless of the distance between the point of analysis and the position of the installation. The fumes' extraction filter probe SO105 (supplied with the AN510) is installed on the flue expansion joint using a 1½" female duct section and the recommended distance between the AN510 unit and the fumes' extraction probe must not exceed 10 metres. Normally, the connecting tube to utilize is made of steel or PTFE with an external diameter of 8mm. The tube is connected to the inlet of the AN510 unit utilizing 10-15 cms of silicone tubing supplied as standard.

Consult the instruction specifications attached to the AN510 unit for further information.

TS352 – Vacuum pressure probe

A probe with two 4-20mA linear outputs and a 0-200 mmH₂O (=1961.33 Pa) scale for the measuring and transmission of the vacuum at the base of the flue and the pressure in the combustion chamber. The probe is composed of a 210mm x 110mm x 120mm aluminium enclosure with class IP55 protection. Inside the enclosure are two measuring circuits and the relative terminals to make the external connections.

The enclosure can be fixed to the wall via the predisposed holes and using two wall plugs, or fitted to cable conduit utilizing the conduit brackets supplied.

The enclosure has two union connections; one on the left for the vacuum at the base of the flue and one on the right for the combustion chamber pressure. The connection between the union connections and the threaded measurement connection joints can be made using steel or copper tubing with an 8mm external diameter or plastic tubing (PVC or silicone tubing, depending on the operating temperature). The threaded measurement connection joints can be made using a union coupling for the tube used.

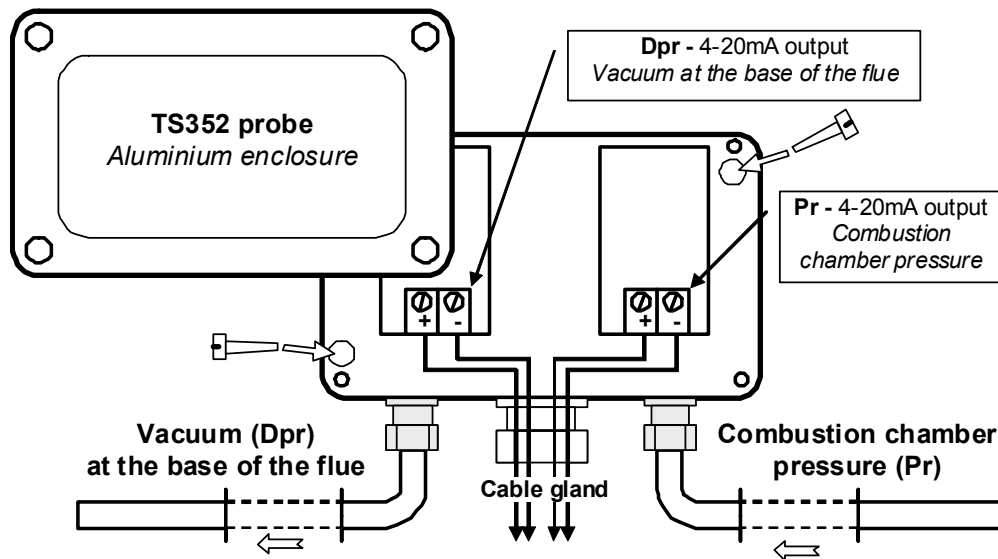

Conversion of the pressure Units of Measure

1 mmH ₂ O	=	9.80665	Pascal
1 mmH ₂ O	=	0.0980665	millibar
1 mmH ₂ O	=	0.00980665	kilopascal
1 Pa	=	0.001	kilopascal
1 Pa	=	0.1019716	mmH ₂ O (millimetre of water [4 °C])
1 Pa	=	0.01	millibar

Example:

200 mmH ₂ O (millimetre of water [4 °C])	=	1961.33 Pa	(Pascal)
2,000 Pa (Pascal)	=	203.95 mmH ₂ O	(millimetre of water [4 °C])

AN400/I – Combustion chamber gas analyzer unit

The AN400/I unit is utilized, wherever required, to indicate and block any gas leaks (e.g., methane) in the combustion chamber due to faults in the adjustment and sealing system of the burner. The AN400/I measures, visualizes and activates the alarms and transmits the value of the concentration detected to the AN750 unit (a 4-20mA signal).

The analyzer unit is composed of a 400 x 500 x 200 mm wall-mounted metal enclosure with class IP55 protection and a glass door. As well as the main switch on the inside of the front panel, there is a digital indicator (ID250) to visualize the concentration of gas.

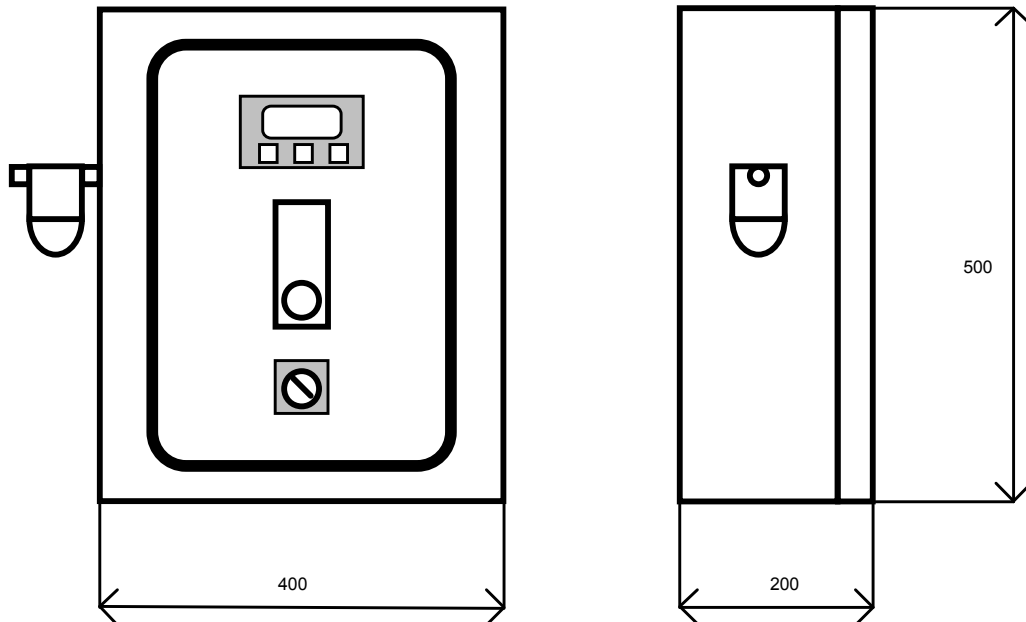

The sensor utilized for detecting gas is a Pellistor catalytic combustion sensor with a 0-100%LIE measuring scale of the calibrated gas (e.g., methane).

The gas analyzer circuit in the combustion chamber of the AN400/I unit includes a coalescent filter, suction pump, suction limiter, three-way valve, flowmeter and the sensor for explosive gases.

The AN400/I unit has been designed in such a way that the gas sensor is washed with ambient air every time the burner is switched on (at the end of each analysis cycle that occurs only when the burner is switched off; when there is no flame).

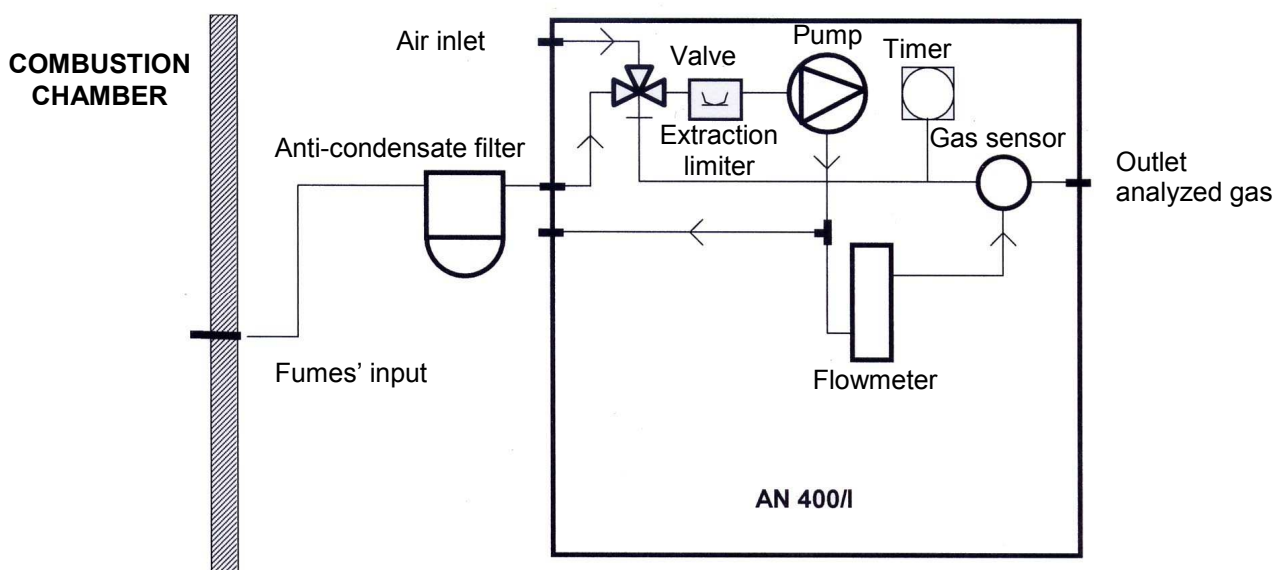

Consult the instruction specifications attached to the TS236 or TS237 for further information.

POSITIONING OF THE MAIN FUMES' ANALYSIS PROBES

The probes are normally installed on the flue expansion joint at a distance of approximately two diameters of the same joint from the combustion chamber. Position the three probes approximately 10-15 cms away from each other, installing first the TS236 oxygen probe, then the TS345 temperature probe and the SO105 (AN510) fumes' extraction probe. If there is not enough space, the probes can be installed diametrically opposed on the flue expansion joint, respecting the order indicated.

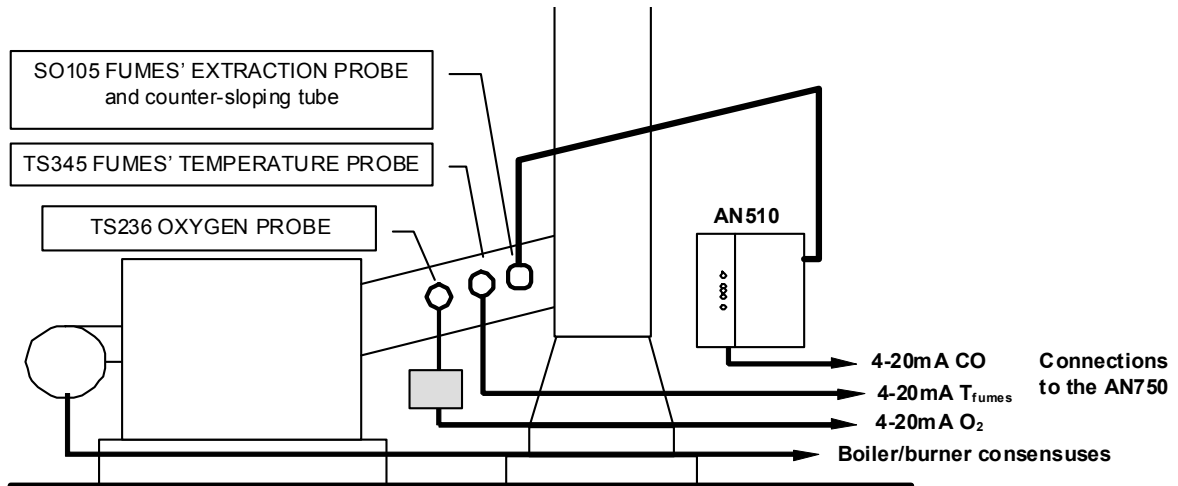

If the flue expansion joint is short, the probes can be installed on the flue at a distance equal to two diameters of the flue starting at the flue expansion joint.

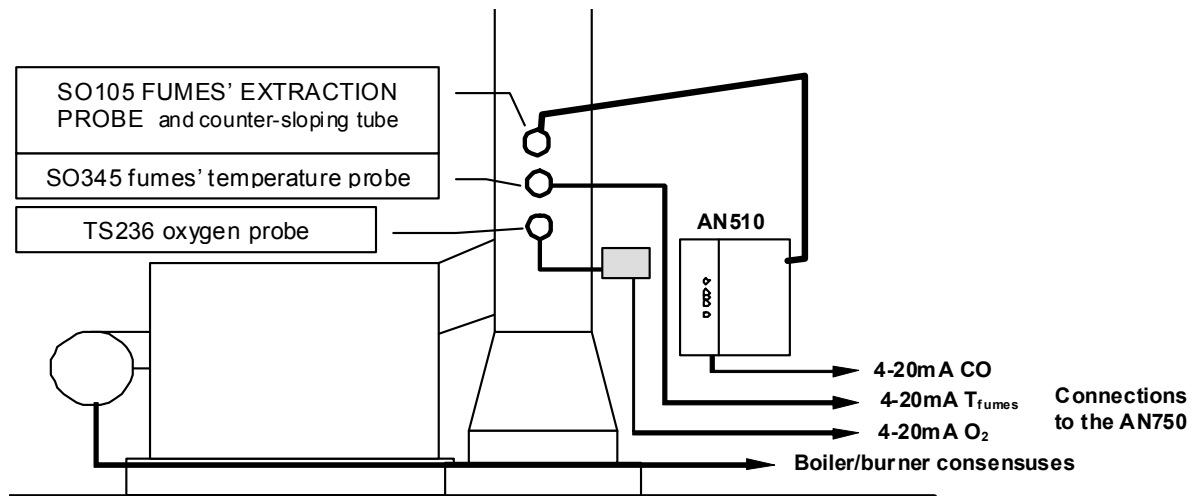

ELECTRICAL CONNECTIONS

The electrical connections to effectuate on the AN750 unit are the electrical mains feed connections (230V-50Hz), the consensuses, the probes (signals 4-20mA) and the alarm contacts if required. All cables must be screened except for the mains feed cable and the consensuses, and they must have a section that permits the correct functioning of the AN750 unit.

Feed (refer to diagram 1)

The 230V AC electrical mains feed cable is connected to the L and N terminals per phase and the neutral terminal of the "PRINTED CIRCUIT BOARD POWER SUPPLY UNIT" obtained from a dedicated line and adequately protected by a thermomagnetic contact breaker switch.

Consensuses (refer to diagram 5)

The boiler consensus (Cc) visualizes and prints even when the boiler is on or off. *The consensus is a clean relay contact and open when the burner is off and closed when the boiler is on.* Utilizing 2 x 0.75 mm² cable connect the input printed circuit board of the AN750 unit to the "Cc" and "-" terminals (the upper of the three levels).

The burner consensus (Cb) is utilized for the memorization of data and to permit the CO analyzer unit to switch on when the burner (flame lit) starts operating and stops the suction pump when the burner is off.

ATTENTION: The AN750 unit does not function if the burner consensus has not been connected. The consensus is a clean relay contact and open when the burner is off and closed when the burner has the flame lit. Utilizing 2 x 0.75 mm² cable, connect the AN750 inputs' printed circuit board to the "Cb" and "-" terminals (the upper of the three levels).

Probe signals (4-20mA) (refer to diagrams 2, 3, 4 and 5)

The 4-20 mA signals relative to the parameters measured are respectively connected to the "BOILER INPUTS' PRINTED CIRCUIT BOARD" (if the probes are installed). *For the 4-20mA signals, a 2 x 0.75 mm² screened cable is utilized. To simplify the laying of cables between the AN750 unit and the probes installed on the boiler, a multi-pole screened cable can be utilized with conductor leads of at least 0.5 mm² section.*

If the following are utilized (refer to diagram 2 and/or 4 and to the notes on page 6):

The TS345 (Pt100) fumes' temperature probe (Tf) utilizing 2 x 0.75 mm² screened cable. Open the cover of the probe and connect:

- Terminal 6 (or 4) "+" to the terminal (the lower of the three levels) "+" of the AN750 inputs' printed circuit board.
- Terminal 7 (or 5) "-" to the terminal (the lower of the three levels) "I2" of the AN750 inputs' printed circuit board.

If the following are utilized (refer to diagram 3 and to the notes on page 6):

The TS346 (Pt100) ambient air temperature probe (Ta) utilizing 2 x 0.75 mm² screened cable. Open the cover of the probe and connect:

- Terminal 6 (or 4) "+" to the terminal (the lower of the three levels) "+" of the AN750 inputs' printed circuit board.
- Terminal 7 (or 5) "-" to the terminal (the lower of the three levels) "I1" of the AN750 inputs' printed circuit board.

Or if the following are utilized (refer to diagram 4 and to the notes on page 6):

The TS345 (Pt100) oxidizing air temperature probe (Ta) utilizing 2 x 0.75 mm² screened cable. Open the cover of the probe and connect:

- Terminal 6 (or 4) "+" to the terminal (the lower of the three levels) "+" of the AN750 inputs' printed circuit board.
- Terminal 7 (or 5) "-" to the terminal (the lower of the three levels) "I1" of the AN750 inputs' printed circuit board.

If the following are utilized (refer to diagram 5 and the design on page 7):

The TS236 oxygen probe is connected to the 230V AC electrical mains circuit as indicated in the instruction specifications and utilizing 2 x 0.75 mm² screened cable connect:

- Terminal "+" to terminal "I5" of the AN750 inputs' printed circuit board.
- Terminal "-" to terminal "-" of the AN750 inputs' printed circuit board.

If the following are utilized (refer to diagram 5):

The AN510 CO analyzer unit (IC, ICN or ICNS) is connected to the 230V AC electrical mains circuit connection indicated in the instruction specifications and utilizing 2 x 0.75 mm² screened cable connect:

- Terminal "U3" (CO) to terminal (the intermediate of the three levels) "I6" of the AN750 inputs' printed circuit board.
- Terminal "-" to terminal (the intermediate of the three levels) "-" of the AN750 inputs' printed circuit board.

Also connect the following if the second optional sensor for NO is installed in the AN510 unit:

- Terminal "U2" (NO) to terminal (the intermediate of the three levels) "I7" of the AN750 inputs' printed circuit board.

Also connect the following if the third optional sensor for SO₂ is installed in the AN510 unit:

- Terminal "U1" (SO₂) to terminal (the intermediate of the three levels) "I8" of the AN750 inputs' printed circuit board.

If the following are utilized (refer to diagram 6):

The AN510/CO CO analyzer unit (without the TS236 probe) is connected to the 230V AC electrical mains circuit as indicated in the instruction specifications and utilizing 2 x 0.75 mm² screened cable connect:

- Terminal "U3" (CO) to terminal (the intermediate of the three levels) "I6" of the AN750 inputs' printed circuit board.
- Terminal "–" to terminal (the intermediate of the three levels) "–" of the AN750 inputs' printed circuit board.
- Terminal "U2" (O₂) to terminal (the intermediate of the three levels) "I5" of the AN750 inputs' printed circuit board.

If the following are utilized (refer to diagram 7 and the design on page 9):

The TS352 vacuum at the base of the flue and pressure in the combustion chamber probe utilizing 4 x 0.75 mm² screened cable connect:

Vacuum at the base of the flue: (left circuit)

- Terminal "+" to terminal (the intermediate of the three levels) "+" of the AN750 inputs' printed circuit board.
- Terminal "–" to terminal (the intermediate of the three levels) "13" of the AN750 inputs' printed circuit board.

Pressure in the combustion chamber: (right circuit)

- Terminal "+" to terminal (the intermediate of the three levels) "+" of the AN750 inputs' printed circuit board.
- Terminal "–" to terminal (the intermediate of the three levels) "14" of the AN750 inputs' printed circuit board.

If the following are utilized (refer to diagram 8):

The AN400/I gas analyzer unit in the combustion chamber is connected to the 230V AC electrical mains circuit, the burner consensus (*electrically separated from the AN750 burner*), the burner block (alarms) as indicated in the instruction specifications utilizing 2 x 0.75 mm² screened cable connect:

- Terminal "3" of the AN400/I to terminal (the intermediate of the three levels) "16" of the AN750 inputs' printed circuit board.
- Terminal "4" of the AN400/I to terminal (the intermediate of the three levels) "–" of the AN750 inputs' printed circuit board.

Alarm relay outputs (refer to diagram 1)

The AN750 unit has an alarm relay for each boiler installed available on the corresponding "BOILER INPUTS' PRINTED CIRCUIT BOARD" and three alarm relays common to all boilers positioned on the "PRINTED CIRCUIT BOARD POWER SUPPLY UNIT". All relays are volt-free clean contacts (terminals C, NC and NA).

The relay positioned on each "BOILER INPUTS' PRINTED CIRCUIT BOARD" has the function of signalling:

COMMON FAULT to all sensors connected to the main printed circuit board of the boiler. The activation of the relay is delayed 60 seconds; the relay resets itself automatically when the fault signal terminates.

The relay positioned on each "PRINTED CIRCUIT BOARD POWER SUPPLY UNIT" has the function of signalling:

ALARM 1: pre-alarm relay common to all probes installed. If programmed in the configuration of single probes, the activation of the relay is delayed for 30 seconds.

ALARM 2: alarm relay common to all probes installed. If programmed in the configuration of single probes, the activation of the relay is delayed for 30 seconds.

ALARM 3: fault relay common to all probes installed. The activation of the relay is delayed 60 seconds; the relay resets itself automatically when the fault signal terminates.

N.B. THE TERMINALS RELATIVE TO THE INPUT TERMINALS ARE ON 3 LEVEL TERMINAL BLOCKS

The terminal block compartment on page 13 is represented with all boiler inputs' printed circuit boards assembled.

DIAGRAM 1 Feed and relay outputs

230V mains circuit connection and alarm and fault's relay common to the 4 boilers

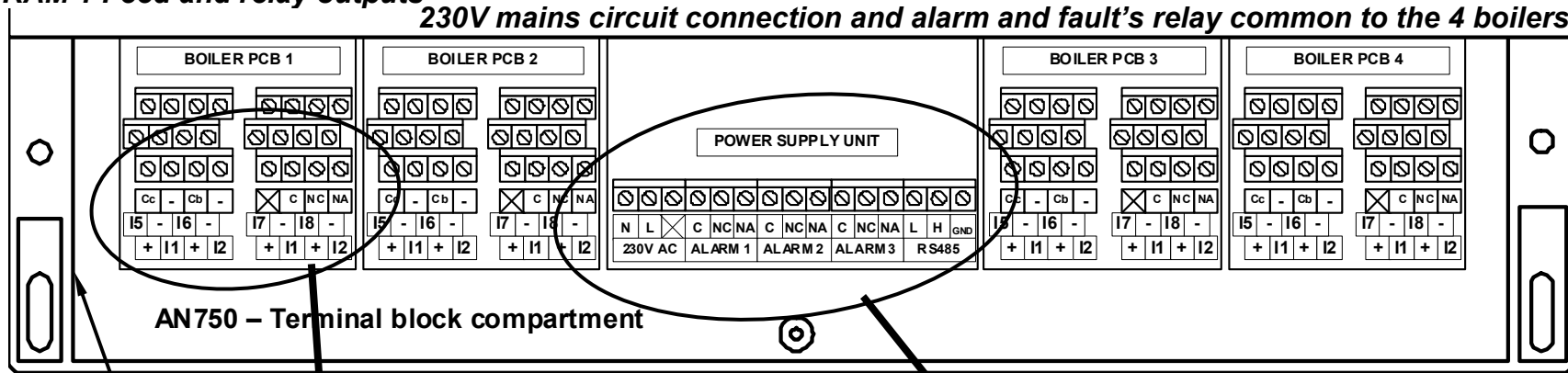

AN750 – Terminal block compartment

**POSITION
Test label**

DIAGRAMS 2, 3, 4 and 5

(Following pages)

POWER SUPPLY UNIT

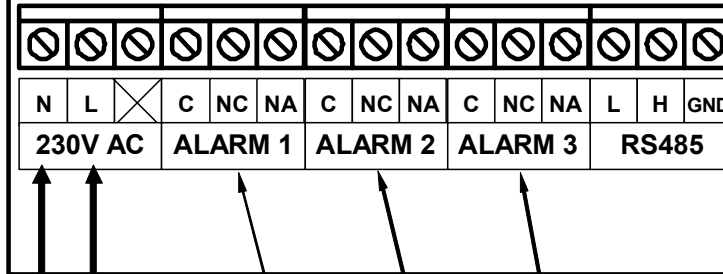

Electrical mains circuit
230V AC-50Hz-22 VA

“FAULT” relay terminals
(common to all probes of the
boilers installed)

ALARM relay terminals
(common to all probes of the
boilers installed)

PRE-ALARM relay terminals
(common to all probes of the
boilers installed)

DIAGRAM 2 Only the TS345 Tf probe. Connection of the TS345 fumes' probe for measuring the temperature of the fumes in the flue expansion joint.

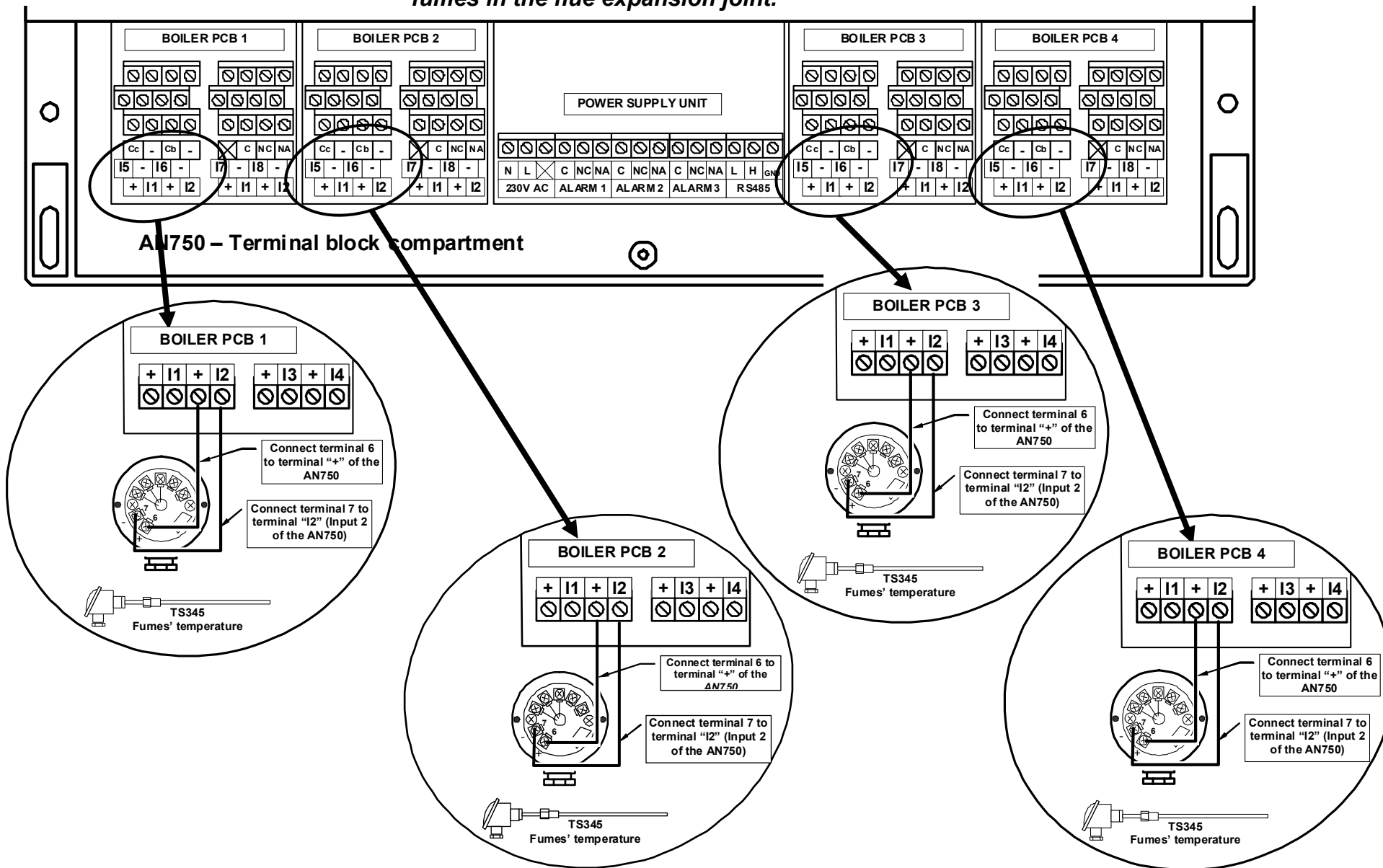

DIAGRAM 3 TS345 Tf and TS346 Ta common probes. *TS346 probe connection for measuring the ambient air temperature that is common to the 4 boilers and the TS345 fumes' probes that measure the fumes' temperature in the flue.*

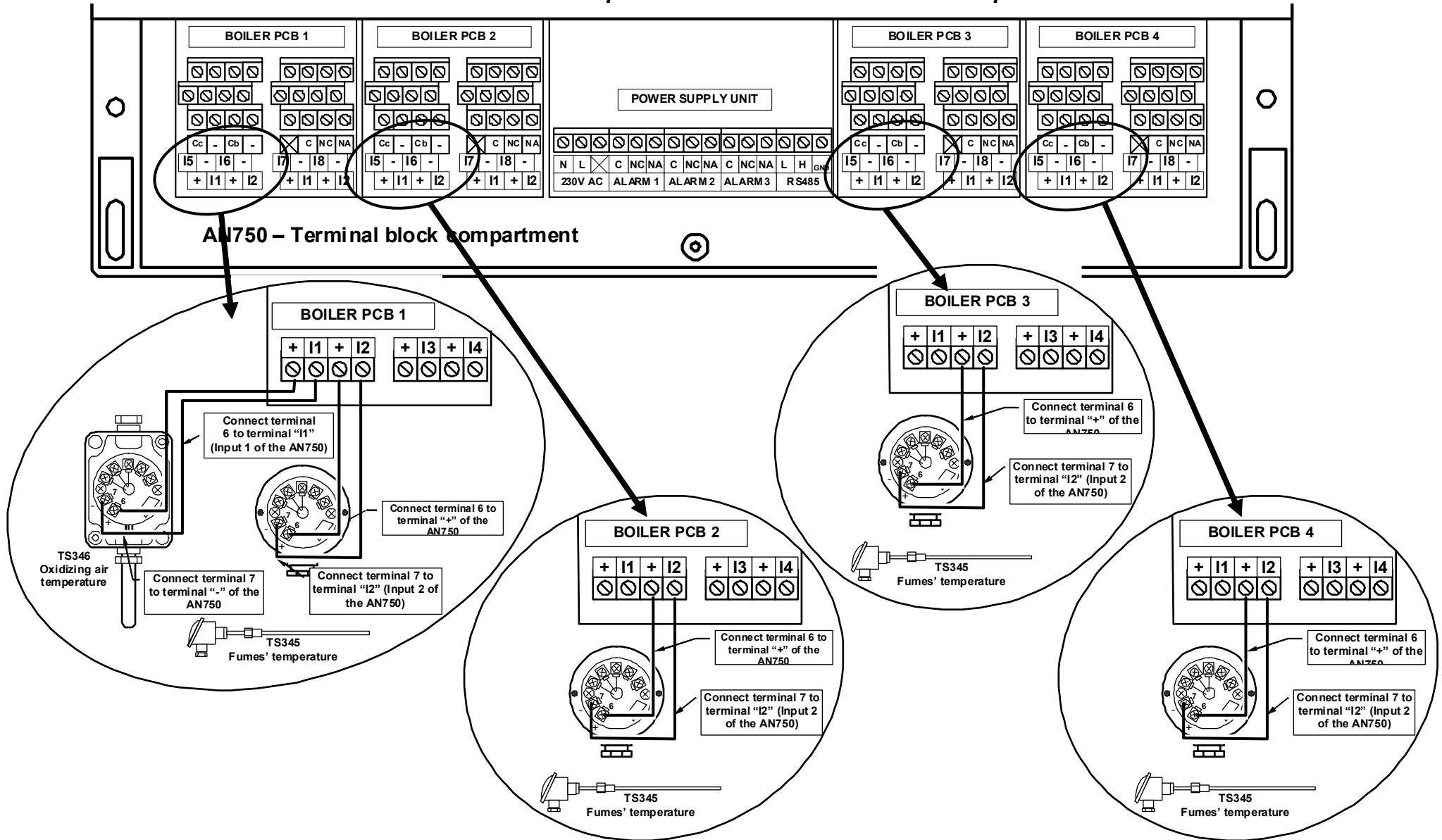

DIAGRAM 4 TS345 probes for Ta and Tf. TS345 probe connection for measuring the pre-heated oxidizing air temperature to the burner of each boiler and the TS345 probes for measuring the fumes' temperature in the respective flue expansion joints.

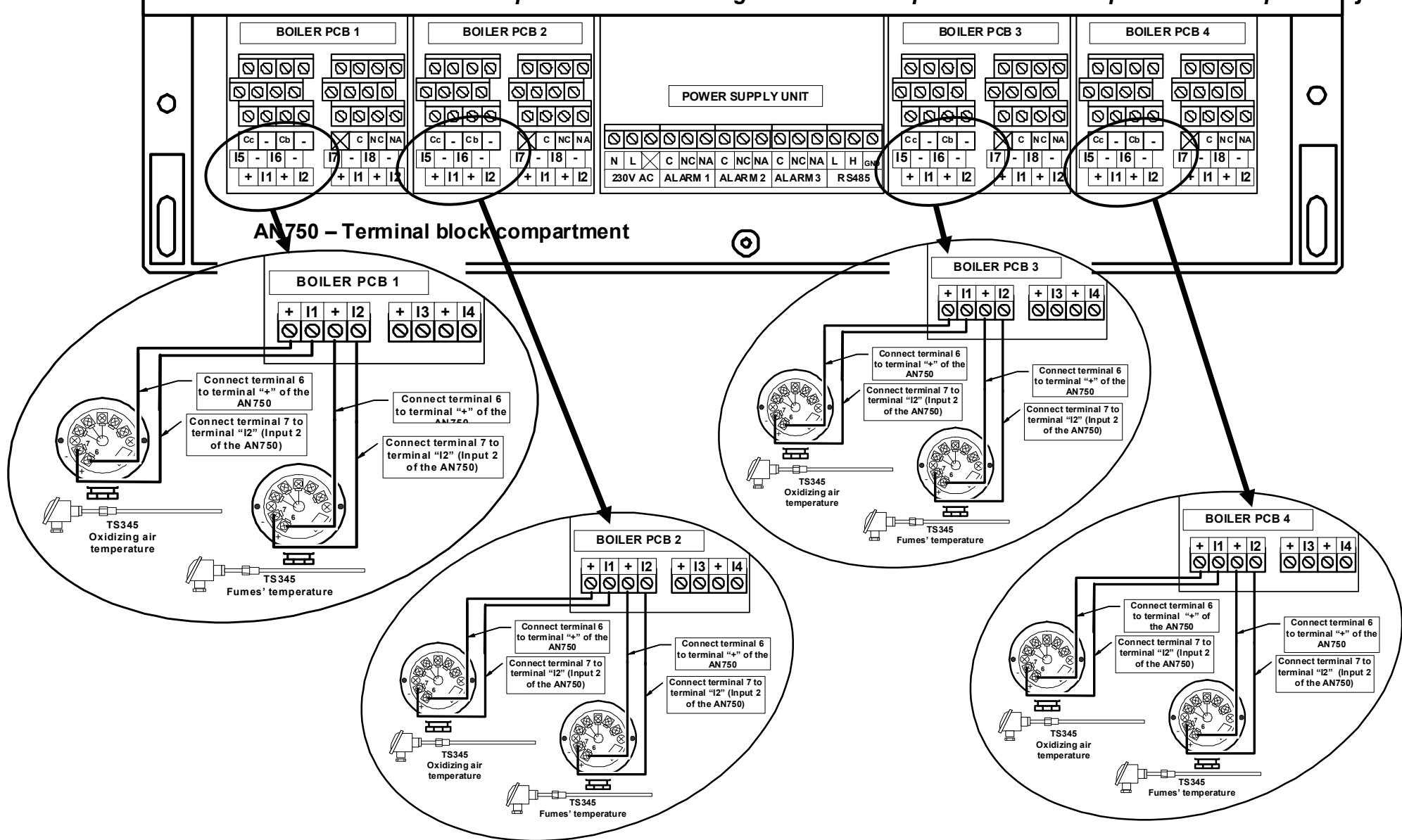

DIAGRAM 5 TS236 and AN510 probes and consensuses. Connection of the consensuses, TS236 O₂ probe and the AN510 (/C, /CN, /CN/) unit to the boiler's main printed circuit board and the fault relay of the printed circuit board (the other boilers' main printed circuit boards are connected in the same way).

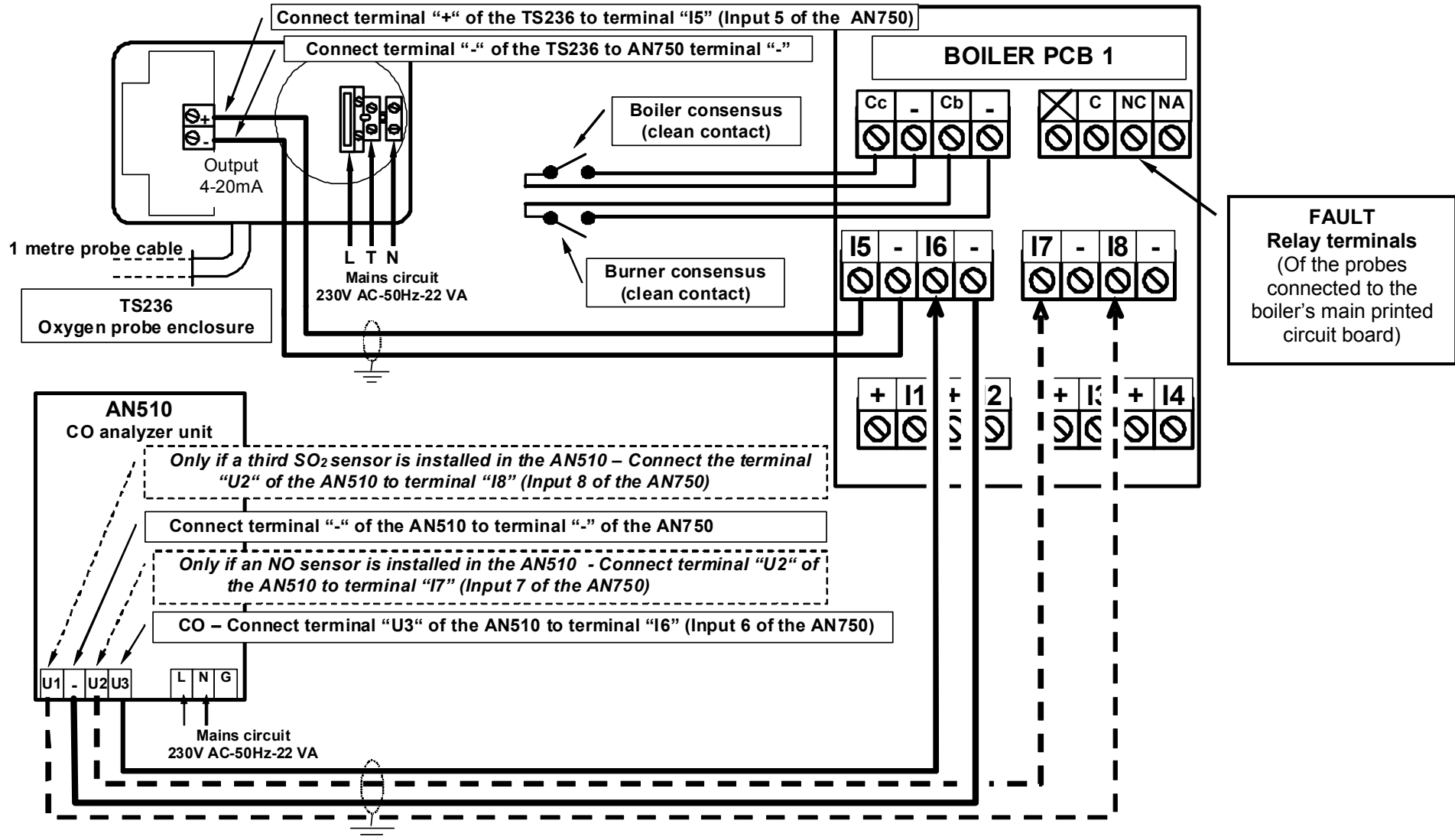

DIAGRAM 6 AN510/CO unit and consensus Connection of the AN510/CO analyzer unit to the boiler's main printed circuit board and the Fault relay of the boiler's main printed circuit board (the other boilers' main printed circuit boards are connected in the same way).

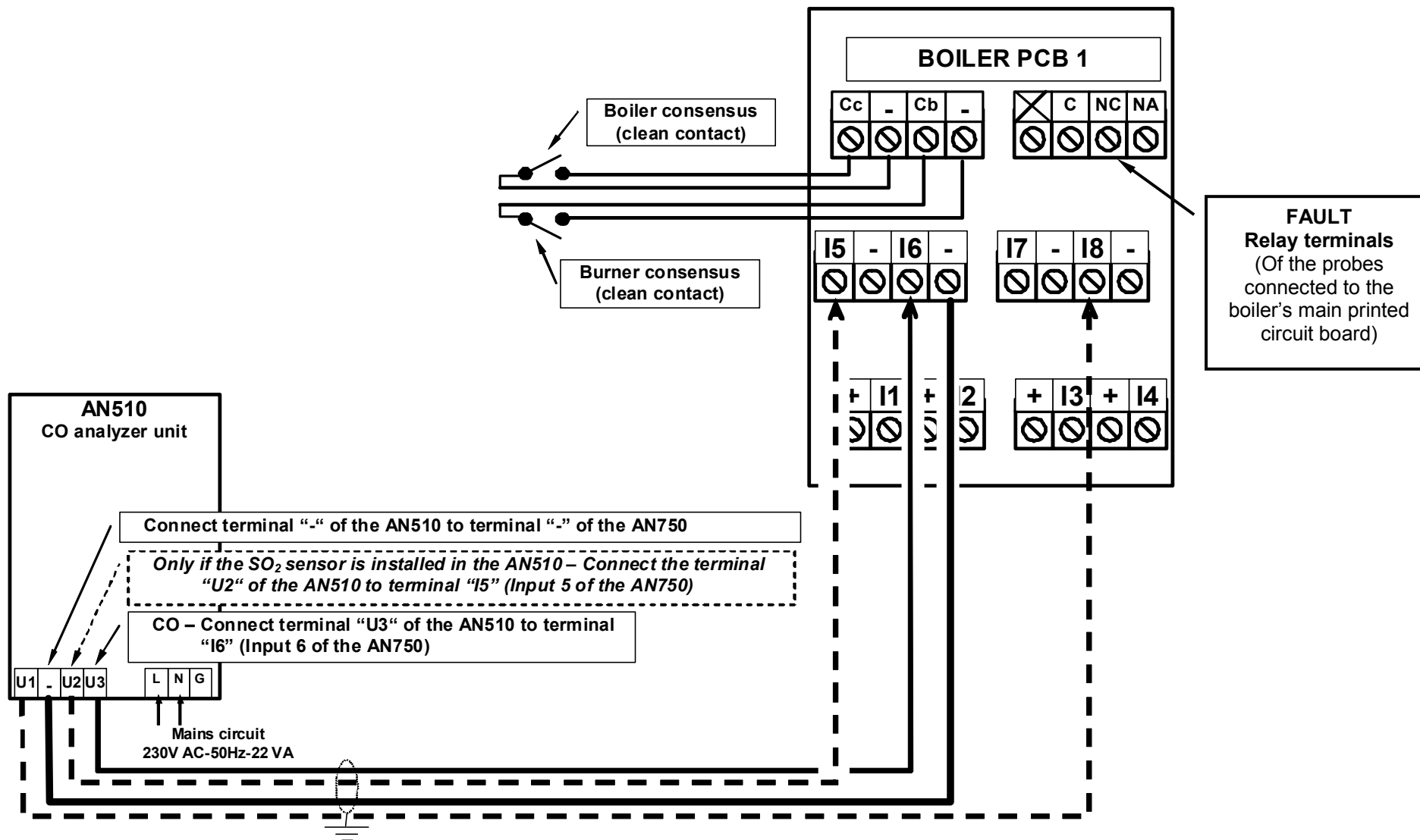

DIAGRAM 7 TS352 Dpr and Pr probes Connection of the TS352 vacuum/pressure probe to the boiler's main printed circuit board (the other boilers' main printed circuit board are connected in the same way).

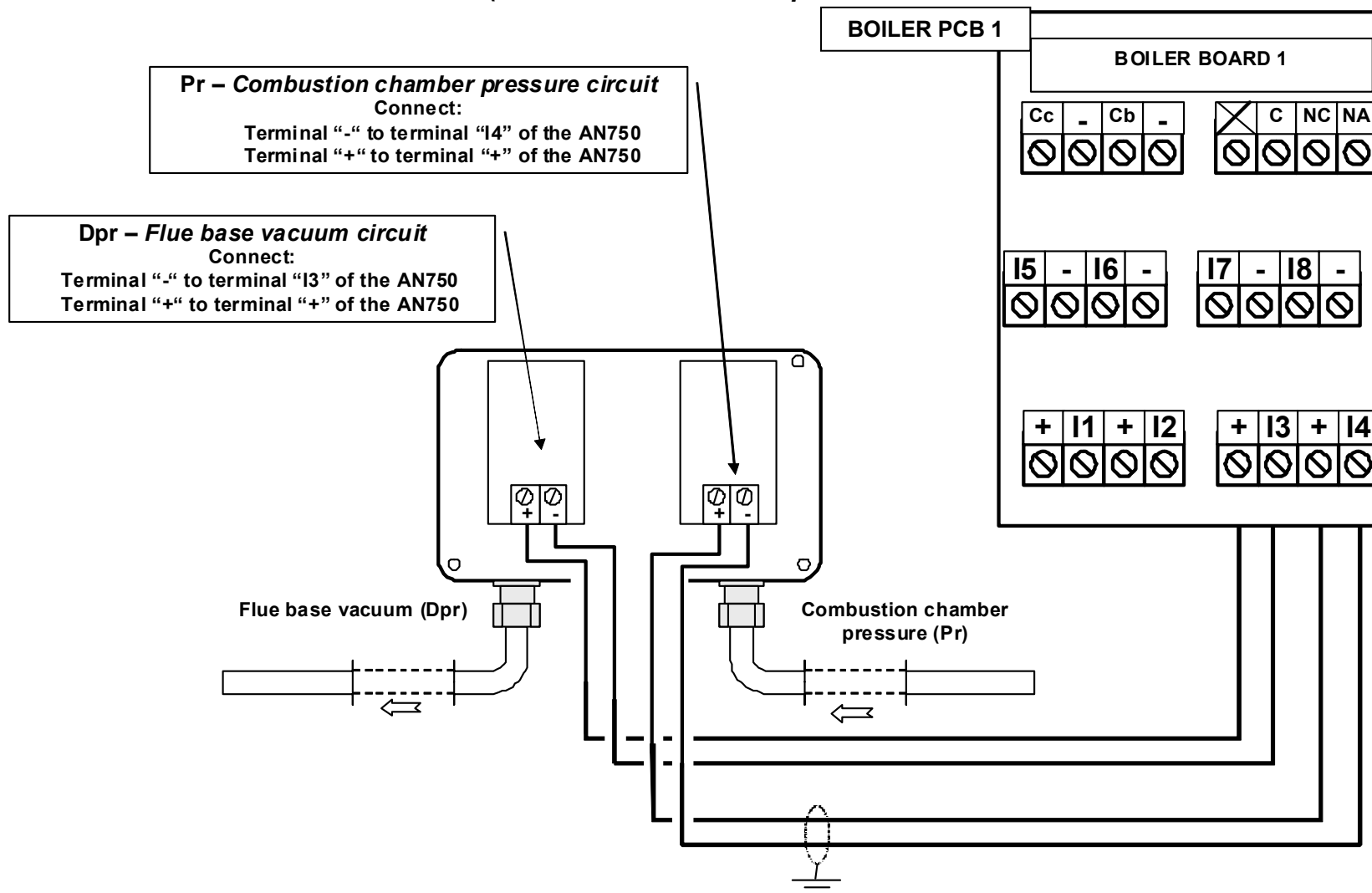
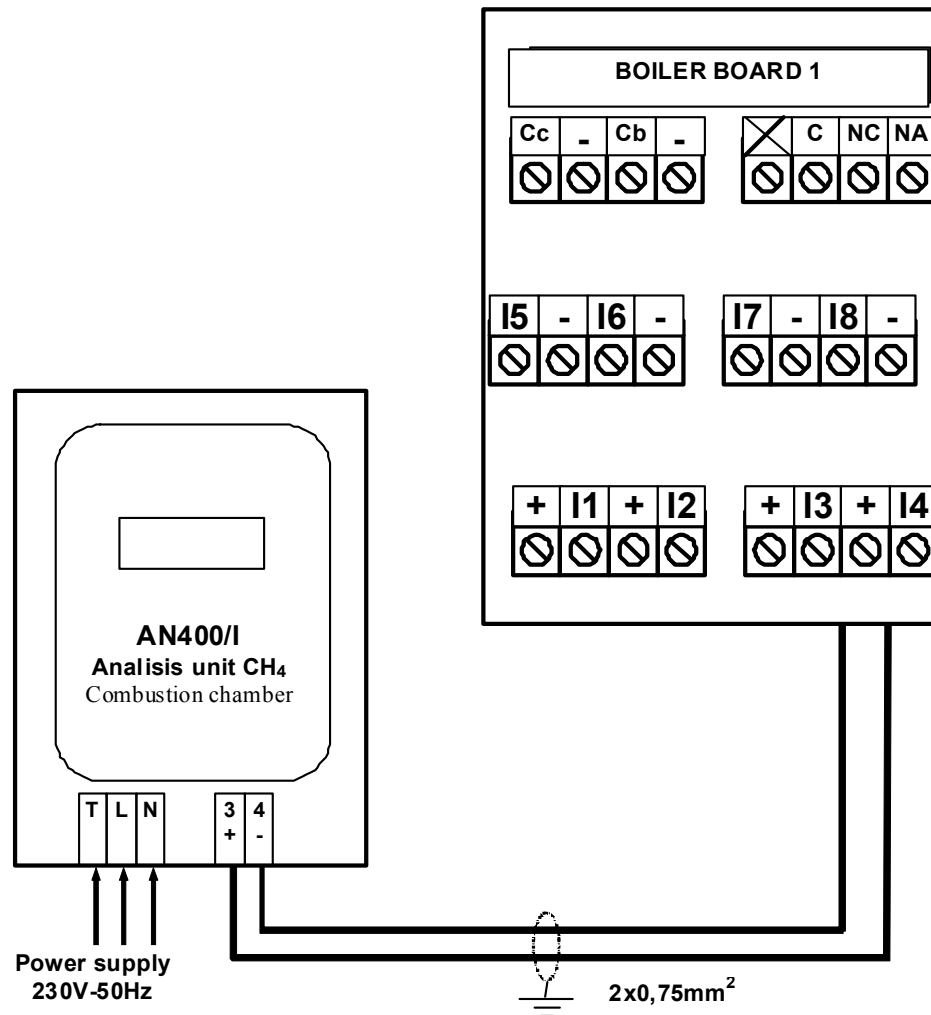

DIAGRAM 8 AN400/I

Connection of the CH₄ analyzer unit in the AN400/I combustion chamber to the boiler's main printed circuit board (the other boilers' main printed circuit boards are connected in the same way). Refer to the instruction specifications for further technical information.



OPERATING THE UNIT

Refer to the AN750 user manual.

ORDINARY MAINTENANCE

Substitution of the thermal paper

To replace the thermal paper (roll width: 57.5 mm) of the printer, remove the used roll from the paper roller unit positioned inside the paper roller unit door of the AN750.

Insert the new roll in the roller compartment, thread the end of the paper through the appropriate slot of the paper roller unit and manually wind for 3-4 turns.

Assistance

On request, TECNOCONTROL offers programmed maintenance contracts at 6 month and 12 month intervals (at the start of the season or halfway through the season) depending on the use and requirements of the customers. The intervention includes the substitution of consumable parts if necessary and the checking and calibration of the sensors installed.

TECHNICAL CHARACTERISTICS

AN750 central unit

Electrical characteristics

- Electrical mains circuit..... 230V AC (+10-15%)
- Absorption 35 VA max
- Protection fuses..... 5 x 20 0.5A
- Analogical inputs 4-20mA passive Max. 4 for each boiler unit
- Analogical inputs 4-20mA active with 19V DC output..... Max. 4 for each boiler unit
- Maximum load 450 ohms
- Consensus' inputs (2 for each boiler unit) Normally closed contact
- Outputs (3 general relays + 1 relay for each boiler)..... 3A 230V AC
- Graphics display: background illuminated in blue ¼" VGA STN 320 x 240 pixel
- Printer with easy loading of the paper rolls Thermal paper 203 dpi graphic
- Thermal paper 57.5 mm wide rolls
- Output signals RS232 (RS485 is optional)

Mechanical characteristics

- Dimensions (w x h x d)..... 370 mm x 317 mm x 150 mm
- Code protection IP65
- Weight Approximately 5 kgs
- Mounting..... Wall

Environmental conditions

- Operating:

Temperature.....	From +5°C to +45°C
Humidity	From 15% to 95%
- Storage:

Temperature.....	from -20°C to +50°C
Humidity	From 15% to 98%

Various

- Firmware version in the AN750 *Menu key, sub-menu version info)*

TS345 temperature probe (Pt100 thermoresistance)

- Output signals 4-20mA linear
- Measuring field 0°C - 400°C
- Probe PT100
- Precision class B
- Response time <1 s for each °C
- Enclosure / length..... DIN B / 400mm

As an alternative to the TS345 TS347 temperature probe (K-type thermocouple)

- *Output signals* *4-20mA Linear*
- *Measuring field* *0°C - 600°C*
- *Probe* *Thermocouple K*
- *Precision class* *± 0.15% of the Full Scale*
- *Response time* *<1 s for each °C*
- *Enclosure / length*..... *DIN B / 500mm*

TS346 ambient temperature probe (Pt100 thermoresistance)

- Output signals 4-20mA linear
- Measuring field 0 - 100°C
- Probe PT100
- Precision class B
- Time constant..... 45 seconds
- Enclosure / dimensions (w x h x d) ABS IP65 / 60 x 140 x 36 mm

TS352 vacuum/pressure probe

- Output signals 2 x 4-20mA linear
- Measuring field 0 - 200 mmH₂O
- Probe 2 x Piezo-resistive
- Enclosure / dimensions (w x h x d) IP55 / 210 x 110 x 20 mm

N.B. Refer to the instruction specifications and attachments for information about other probes (TS236, AN510/... and AN400/I).